

TL704H
TekLink 4 Port Instrument Hub
User Manual



071-2114-01

Tektronix

TL704H
TekLink 4 Port Instrument Hub
User Manual

www.tektronix.com
071-2114-01



Copyright © Tektronix. All rights reserved. Licensed software products are owned by Tektronix or its subsidiaries or suppliers, and are protected by national copyright laws and international treaty provisions.

Tektronix products are covered by U.S. and foreign patents, issued and pending. Information in this publication supersedes that in all previously published material. Specifications and price change privileges reserved.

TEKTRONIX and TEK are registered trademarks of Tektronix, Inc.

TekLink is a registered trademark of Tektronix, Inc.

Contacting Tektronix

Tektronix, Inc.
14200 SW Karl Braun Drive
P.O. Box 500
Beaverton, OR 97077
USA

For product information, sales, service, and technical support:

- In North America, call 1-800-833-9200.
- Worldwide, visit www.tektronix.com to find contacts in your area.

Warranty

Tektronix warrants that this product will be free from defects in materials and workmanship for a period of one (1) year from the date of shipment. If any such product proves defective during this warranty period, Tektronix, at its option, either will repair the defective product without charge for parts and labor, or will provide a replacement in exchange for the defective product. Parts, modules and replacement products used by Tektronix for warranty work may be new or reconditioned to like new performance. All replaced parts, modules and products become the property of Tektronix.

In order to obtain service under this warranty, Customer must notify Tektronix of the defect before the expiration of the warranty period and make suitable arrangements for the performance of service. Customer shall be responsible for packaging and shipping the defective product to the service center designated by Tektronix, with shipping charges prepaid. Tektronix shall pay for the return of the product to Customer if the shipment is to a location within the country in which the Tektronix service center is located. Customer shall be responsible for paying all shipping charges, duties, taxes, and any other charges for products returned to any other locations.

This warranty shall not apply to any defect, failure or damage caused by improper use or improper or inadequate maintenance and care. Tektronix shall not be obligated to furnish service under this warranty a) to repair damage resulting from attempts by personnel other than Tektronix representatives to install, repair or service the product; b) to repair damage resulting from improper use or connection to incompatible equipment; c) to repair any damage or malfunction caused by the use of non-Tektronix supplies; or d) to service a product that has been modified or integrated with other products when the effect of such modification or integration increases the time or difficulty of servicing the product.

THIS WARRANTY IS GIVEN BY TEKTRONIX WITH RESPECT TO THE PRODUCT IN LIEU OF ANY OTHER WARRANTIES, EXPRESS OR IMPLIED. TEKTRONIX AND ITS VENDORS DISCLAIM ANY IMPLIED WARRANTIES OF MERCHANTABILITY OR FITNESS FOR A PARTICULAR PURPOSE. TEKTRONIX' RESPONSIBILITY TO REPAIR OR REPLACE DEFECTIVE PRODUCTS IS THE SOLE AND EXCLUSIVE REMEDY PROVIDED TO THE CUSTOMER FOR BREACH OF THIS WARRANTY. TEKTRONIX AND ITS VENDORS WILL NOT BE LIABLE FOR ANY INDIRECT, SPECIAL, INCIDENTAL, OR CONSEQUENTIAL DAMAGES IRRESPECTIVE OF WHETHER TEKTRONIX OR THE VENDOR HAS ADVANCE NOTICE OF THE POSSIBILITY OF SUCH DAMAGES.

[W2 – 15AUG04]

Table of Contents

General Safety Summary	iii
Compliance Information	vi
EMC Compliance	vi
Environmental Considerations.....	viii
Preface.....	ix
Key Features.....	ix
Installation	1
Standard Accessories	1
Optional Accessories	2
Controls and Connectors	3
Connecting Power	4
Connecting Cables.....	6
Mounting the Hub	7
Troubleshooting.....	8
Specifications	11

General Safety Summary

Review the following safety precautions to avoid injury and prevent damage to this product or any products connected to it.

To avoid potential hazards, use this product only as specified.

Only qualified personnel should perform service procedures.

While using this product, you may need to access other parts of a larger system. Read the safety sections of the other component manuals for warnings and cautions related to operating the system.

To Avoid Fire or Personal Injury

Use Proper Power Cord. Use only the power cord specified for this product and certified for the country of use.

Ground the Product. This product is grounded through the grounding conductor of the power cord. To avoid electric shock, the grounding conductor must be connected to earth ground. Before making connections to the input or output terminals of the product, ensure that the product is properly grounded.

Observe All Terminal Ratings. To avoid fire or shock hazard, observe all ratings and markings on the product. Consult the product manual for further ratings information before making connections to the product.

Do not apply a potential to any terminal, including the common terminal, that exceeds the maximum rating of that terminal.

Power Disconnect. The power cord disconnects the product from the power source. Do not block the power cord; it must remain accessible to the user at all times.

Do Not Operate Without Covers. Do not operate this product with covers or panels removed.

Do Not Operate With Suspected Failures. If you suspect that there is damage to this product, have it inspected by qualified service personnel.

Avoid Exposed Circuitry. Do not touch exposed connections and components when power is present.

Use Proper AC Adapter. Use only the AC adapter specified for this product.

Do Not Operate in Wet/Damp Conditions.

Do Not Operate in an Explosive Atmosphere.

Keep Product Surfaces Clean and Dry.

Terms in this Manual

These terms may appear in this manual:



WARNING. *Warning statements identify conditions or practices that could result in injury or loss of life.*



CAUTION. *Caution statements identify conditions or practices that could result in damage to this product or other property.*

Symbols and Terms on the Product

These terms may appear on the product:

- DANGER indicates an injury hazard immediately accessible as you read the marking.

- WARNING indicates an injury hazard not immediately accessible as you read the marking.
- CAUTION indicates a hazard to property including the product.

The following symbol(s) may appear on the product:



CAUTION
Refer to Manual

Compliance Information

This section lists the EMC (electromagnetic compliance), safety, and environmental standards with which the instrument complies.

EMC Compliance

EC Declaration of Conformity – EMC

Meets intent of Directive 2004/108/EC for Electromagnetic Compatibility. Compliance was demonstrated to the following specifications as listed in the Official Journal of the European Communities:

EN 61326-1 2006. EMC requirements for electrical equipment for measurement, control, and laboratory use. ^{1 2}

- CISPR 11:2003. Radiated and conducted emissions, Group 1, Class A
- IEC 61000-4-2:2001. Electrostatic discharge immunity
- IEC 61000-4-3:2002. RF electromagnetic field immunity
- IEC 61000-4-4:2004. Electrical fast transient / burst immunity
- IEC 61000-4-5:2001. Power line surge immunity
- IEC 61000-4-6:2003. Conducted RF immunity
- IEC 61000-4-11:2004. Voltage dips and interruptions immunity ³

EN 61000-3-2:2006. AC power line harmonic emissions

EN 61000-3-3:1995. Voltage changes, fluctuations, and flicker

European Contact.

Tektronix UK, Ltd.
Western Peninsula
Western Road
Bracknell, RG12 1RF
United Kingdom

- 1 **This product is intended for use in nonresidential areas only. Use in residential areas may cause electromagnetic interference.**
- 2 **To ensure compliance with the EMC standards listed here, high-quality shielded interface cables should be used.**
- 3 **Performance Criterion C applied at the 70%/25 cycle Voltage-Dip and the 0%/250 cycle Voltage-Interruption test levels (IEC 61000-4-11).**

Australia / New Zealand Declaration of Conformity – EMC

Complies with the EMC provision of the Radiocommunications Act per the following standard, in accordance with ACMA:

- CISPR 11:2003. Radiated and Conducted Emissions, Group 1, Class A, in accordance with EN 61326-1:2006.

Environmental Considerations

This section provides information about the environmental impact of the product.

Product End-of-Life Handling

Observe the following guidelines when recycling an instrument or component:

Equipment Recycling. Production of this equipment required the extraction and use of natural resources. The equipment may contain substances that could be harmful to the environment or human health if improperly handled at the product's end of life. In order to avoid release of such substances into the environment and to reduce the use of natural resources, we encourage you to recycle this product in an appropriate system that will ensure that most of the materials are reused or recycled appropriately.



This symbol indicates that this product complies with the applicable European Union requirements according to Directives 2002/96/EC and 2006/66/EC on waste electrical and electronic equipment (WEEE) and batteries. For information about recycling options, check the Support/Service section of the Tektronix Web site (www.tektronix.com).

Restriction of Hazardous Substances

This product has been classified as Monitoring and Control equipment, and is outside the scope of the 2002/95/EC RoHS Directive.

Preface

This manual describes the installation and operation of the TL704H TekLink 4 Port Instrument Hub. The hub allows you to connect up to 4 instruments together into a test and measurement network (a TekLink system). The multi-instrument TekLink system has hardware and software features available beyond the capabilities of a single instrument.

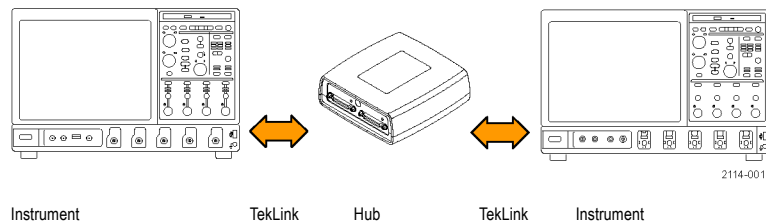

Key Features

Key features include:

- Four ports allowing any four TekLink-equipped instruments to form a TekLink system
- Complex trigger functions from multiple instruments
- Interoperability between logic analyzers, oscilloscopes, signal sources, and spectrum analyzers.
- Sharing trigger events, reference clocks and GPIB commands between instruments in the TekLink system

Installation

Unpack the hub and check that you received all of the items listed below as standard accessories. Check the Tektronix Web site (www.tektronix.com) for the most current information.

Standard Accessories

Description	Part number
User Manual	071-2114-01
External power supply (and one of the following:)	119-5883-00
United States power cord	161-0066-00
Universal European power cord	161-0066-09
United Kingdom power cord	161-0066-10
Australia power cord	161-0066-13
Switzerland power cord	161-0154-00
Japan power cord	161-A005-00
China power cord	161-0304-00
India/South Africa power cord	161-0400-00
No power cord or power supply (Option A99)	

Optional Accessories

Description	Part number
TekLink cable	174-5019-xx

Controls and Connectors

1. Port connectors for connection to each instrument.
2. Port Status indicators. LEDs indicate the presence of a TekLink connection and blink when commands are issued over the TekLink system. (See Table 1 on page 10.)
3. Power Connector. For use with the external power supply, Tektronix part number 119-5883-00.

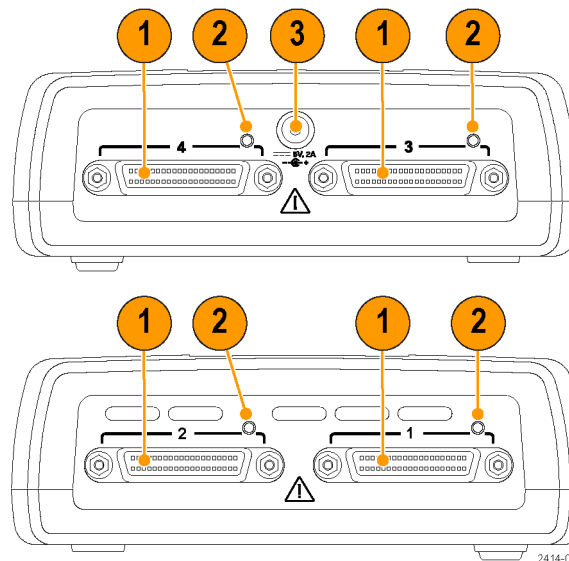

Connecting Power

Connect power to the hub using the external power supply:

Connecting the External Power Supply

To apply power to your hub from the external power supply, do the following procedure:

1. Connect the output power cable from the power supply to the 5 VDC connector on the rear panel of the hub.
2. Connect one end of the power cord to the external power supply.
3. Connect the other end of the power cord to the wall power outlet.

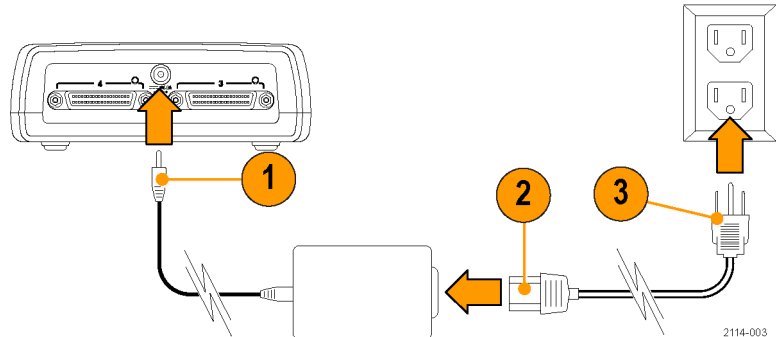

4. Verify that the status LEDs turn on and then off. The LEDs remain off until a TekLink instrument is connected to the hub, establishing a TekLink connection.

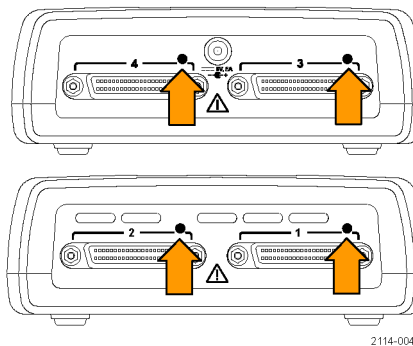

2114-004

Connecting Cables

NOTE. The following cables can be connected while the instruments are powered on.

To connect the hub to TekLink cables, do the following procedure:

1. Connect a TekLink cable to a TekLink port on the hub.
2. Connect the other end of the TekLink cable to the connector on the instrument.

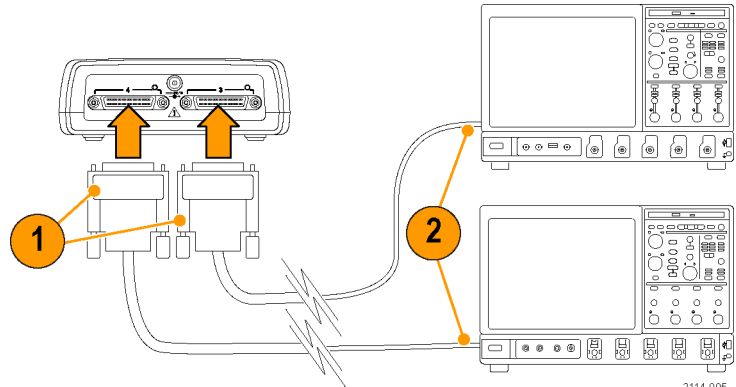

Mounting the Hub

You can mount the hub to a surface, such as an existing rackmount tray or to a bracket of your design, by doing the following procedure:

1. Remove the four adhesive-backed, plastic feet from the hub.
2. Refer to the dimensions shown in the illustration, and drill holes in the mounting surface for two screws.



CAUTION. Using screws that are too long will damage the internal circuitry. Screws should enter the chassis ≤ 0.4 in. (1.03 cm).

3. Mount the hub using two 6-32 screws of appropriate length.

NOTE. Some rackmount kits have provisions for mounting accessories, such as the hub.

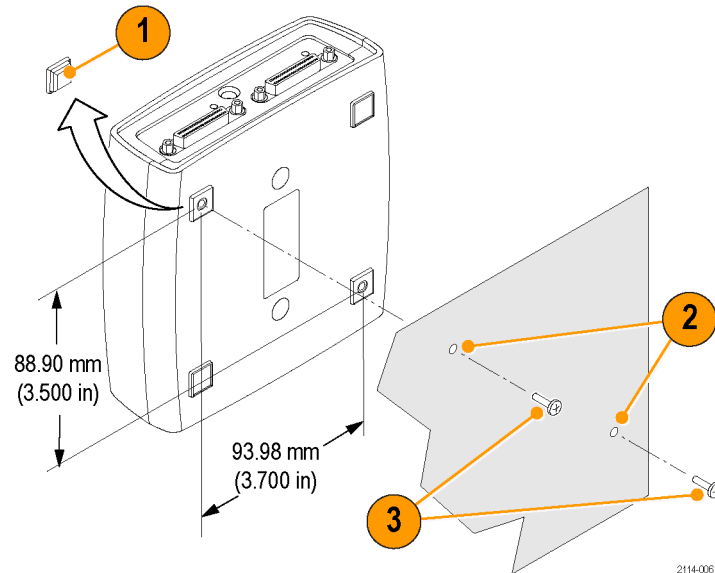

Troubleshooting

Before starting to troubleshoot, note the following:

- There are no user serviceable parts.
- There is no performance verification procedure.

If your hub does not appear to work, do the following checks:

1. Check the cables.

The TekLink cables should be fully inserted on both the TekLink hub and the instrument. Failure means the cables were not inserted correctly or the cables failed.

2. Check the power.

There is no direct indication the hub is powered on. You must check power by observing the status LEDs on the ports. Remove the power cord and plug the power cord back in. The status LEDs should briefly flash amber and then turn off. Failure implies either the hub power system failed or the external power supply failed.

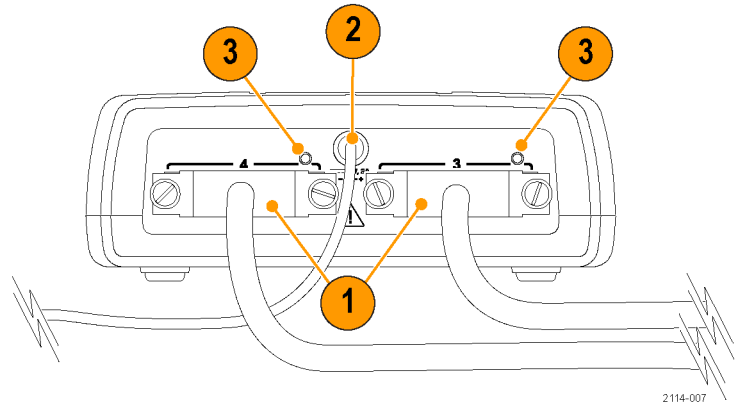

2114-007

3. Check the port status LED.

A status LED should be illuminated amber if you expect a TekLink connection to exist. There are periods of time when TekLink will not function:

- When an instrument is first powering on; the operating system drives the TekLink hardware and it is necessary for the operating system to be running to establish a TekLink connection.
- When a hub is first powering on: the hub will perform initialization tasks before establishing a TekLink connection.
- Failure implies the cable may be bad, the TekLink Ethernet device in the instrument has failed, or the Ethernet system in the hub has failed.

4. Check the indicator lights.

The Hub Status indicator lights on the hub should be in their normal settings. To check them, refer to the following table:

Table 1: Hub status LED

Color	Illumination	Description
Yellow	Solid	A TekLink connection has been established with an instrument.
	Blinking	TekLink communication is occurring over the connection.
None	Off	The hub is either off or waiting for a TekLink connection.

Specifications

Miscellaneous characteristics

Characteristic	Description
Current Consumption	<0.5 ADC from 5 V

Atmospherics

Characteristic	Description
Temperature	Operating: 0 °C to +50 °C (32 °F to +122 °F) Nonoperating: -20 °C to +60 °C (-4 °F to +140 °F)

Atmospherics (cont.)

Characteristic	Description
Humidity	Operating: High: 40 °C to 50 °C (104 °F to 122 °F), 10% to 60% relative humidity Low: 0 °C to 40 °C (32 °F to 104 °F), 10% to 90% relative humidity Nonoperating: High: 40 °C to 60 °C (104 °F to 140 °F), 5% to 60% relative humidity Low: 0 °C to 40 °C (32 °F to 104 °F), 5% to 90% relative humidity
Altitude	Operating: Up to 3,000 m (10,000 ft.) Nonoperating: Up to 15,240 m (50,000 ft.)

Physical characteristics

Characteristic	Description
Height	48.25 mm (1.90 in)
Width	133.35 mm (5.25 in)
Depth	133.35 mm (5.25 in)
Weight	560 g (1.25 lb)